

HANSEN

SCREEN ENCLOSURES INC.
ALUMINUM BUILD IT YOURSELF

GARAGE SCREEN SLIDERS

Retail Manager

See Our Showroom

**11840 Metro Pkwy.
Ft. Myers, Fl 33912**

CALL

239-936-9678

fax: 239-278-1996

cell:

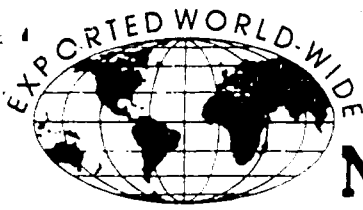

METALTECH, INC. EST. 1957

Weatherwall Division

Manufacturers of Window Enclosure Systems, Insulated Roof and Wall Systems

MEASURING GARAGE DOOR UNITS

Be sure to measure both width and height in several places and work with the smallest dimension.

Since the opening must normally be lined with 1"x 2" for mounting surface, deduct 2" in width and 1" in height before placing the order.

For arched openings, units must be mounted on outside (face) of building.

INSTALLATION GARAGE DOOR UNITS

Garage door units are normally installed "reverse". Assemble main frame with pop rivets furnished. Be sure to face weep holes to the outside, for proper water drainage.

Set main frame into opening and attach to 1"x 2" using a vent as a square for main frame.

Cut threshold and attach to concrete on both sides of sill track.

Place vents in track and install latches.

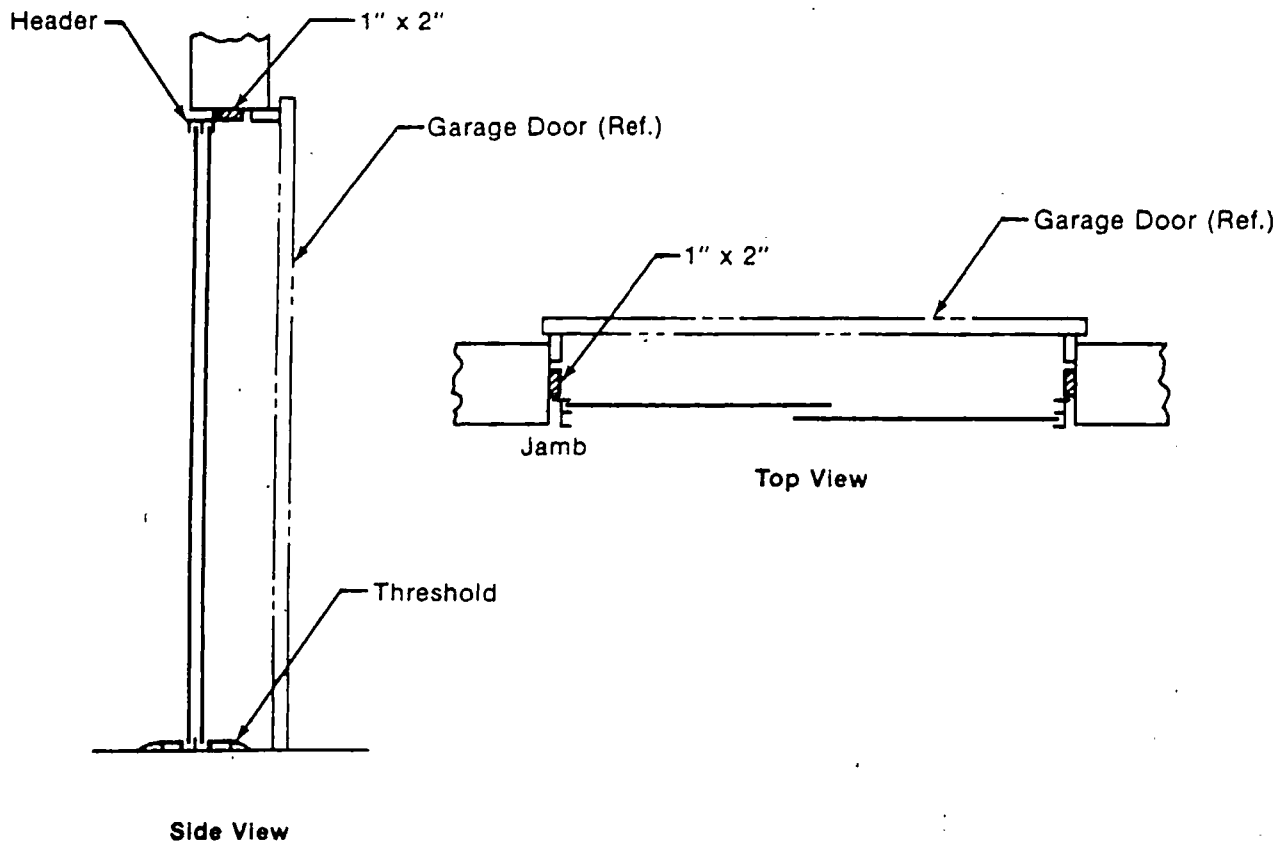

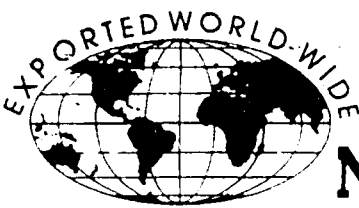

METALTECH, INC. EST. 1957

Weatherwall Division

Manufacturers of Window Enclosure Systems, Insulated Roof and Wall Systems

TWO AND FOUR TRACK GARAGE DOOR SCREENS WITH KICKPLATE

Almost every home with a garage, houses a Potential Customer for the **WEATHERWALL** Garage Door Screen. Wouldn't it be nice to be able to enjoy the garage area without being bothered by insects?

With a Two Track Garage door Screen in a 16' opening, the customer can drive in or out without removing the panels. With a Four Track Garage Door Screen, up to 75% clear opening can be gained.

Both Durable and Attractive, the all Aluminum Frame is available in Bronze or White. Threshold in Mill Finish only.

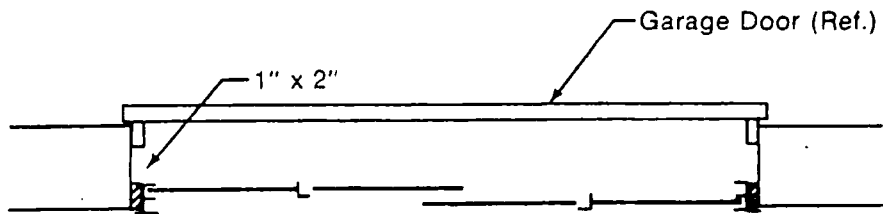

Top View
2 Track 4 Vent Unit

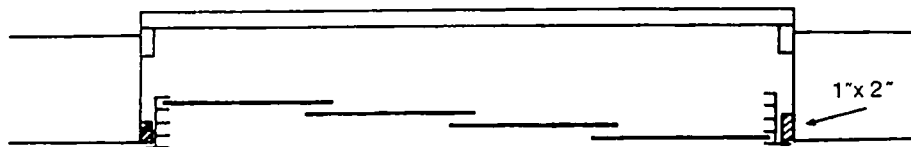

Top View
4 Track 4 Vent Unit

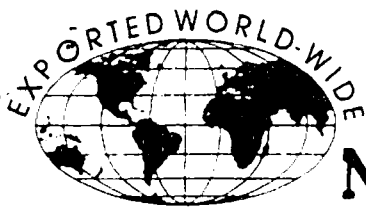

METALTECH, INC. EST. 1957

Weatherwall Division

Manufacturers of Window Enclosure Systems, Insulated Roof and Wall Systems

Garage Door Screens

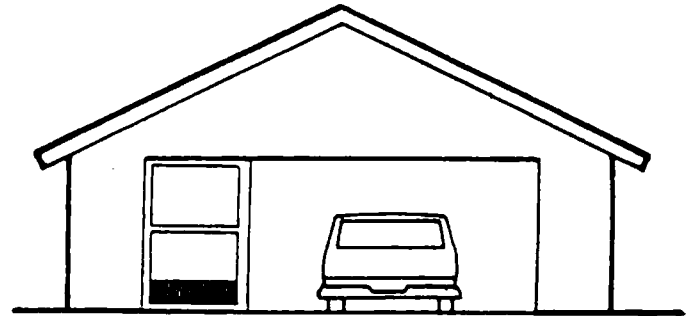
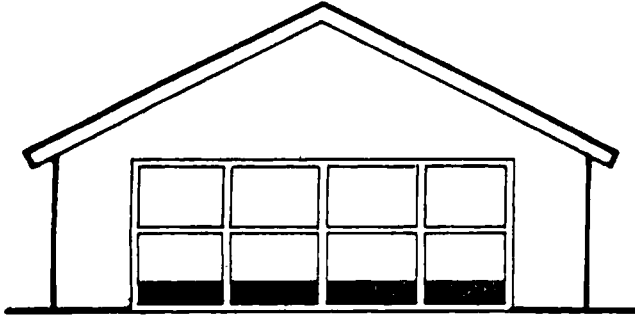

Garage Door (Ref.)

2 TRACK 4 VENT

4 TRACK 4 VENT

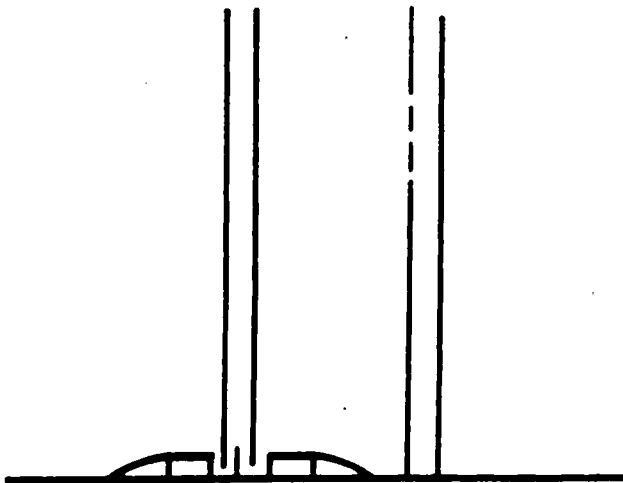

THRESHOLD

SIDE
VIEW

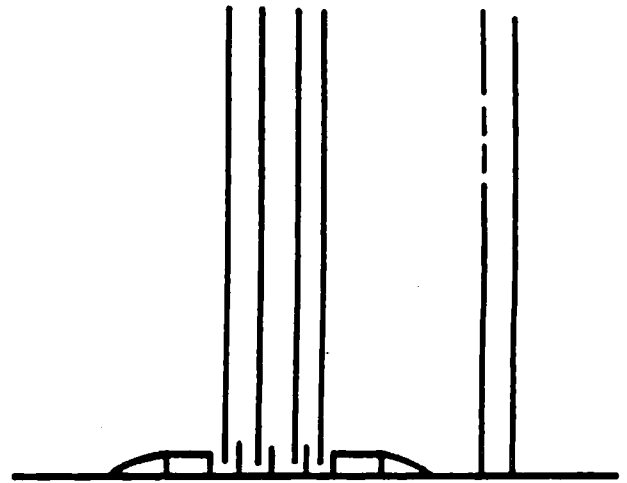

THRESHOLD

Convert your garage into an insect free or water tight work shop with our screen, or vinyl slider unit.

Optional 8" or 16", white or bronze aluminum kick panel at bottom. Double thresholds enable you to drive your car over the tracks. Available in a 2 track 4 vent or 4 track 4 vent horizontal design. Also ideal for separating your porch area from your pool, privacy wall and wind braker around your pool for those windy and dusty days.